

NP12-2.9Ah 12V2.9Ah

Valve Regulated Lead Acid Battery



Specifications

Nominal voltage	12V (6 cells per unit)	
Rated capacity (20HR)	2.9Ah/10.5V	
Dimensions	Length	79±2mm (3.11inch)
	Width	56±1mm (2.20inch)
	Height	99±1mm (3.90inch)
	Total height	104±1mm (4.09inch)
Approx. weight	1.05kg (2.31lbs)±5%	

Outer dimensions (mm)

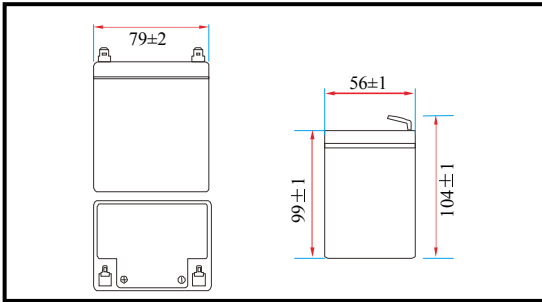

Terminal type (mm)

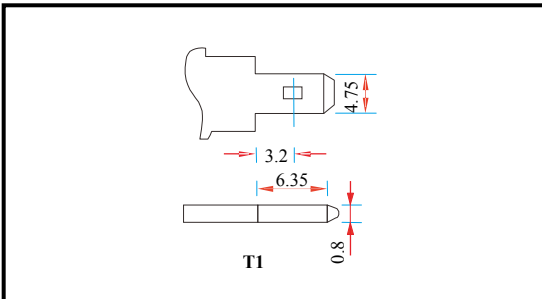

Characteristics

Capacity (25°C)	20HR (10.5V)	2.9Ah
	10HR (10.5V)	2.7Ah
	1HR (9.60V)	1.8Ah
Terminal type		T1
Internal resistance (Fully charged, 25°C)		Approx. 45mΩ
Capacity affected by temperature (10HR)	40°C	102%
	25°C	100%
	0°C	85%
	-15°C	65%
Self-discharge (25°C)	3 months	Remaining capacity: 91%
	6 months	Remaining capacity: 82%
	12 months	Remaining capacity: 65%
Nominal operating temperature		25°C±3°C (77°F±5°F)
Operating temperature range	Discharge	-15°C~50°C (5°F~122°F)
	Charge	-10°C~50°C (14°F~122°F)
	Storage	-20°C~50°C (-4°F~122°F)
Float charging voltage (25°C)		13.60 to 13.80V Temperature compensation: -18mV/°C/Block
Cyclic charging voltage (25°C)		14.50 to 15.00V Temperature compensation: -30mV/°C/Block
Maximum charging current		0.87A
Maximum discharge current		43.5A (5 sec.)
Design life	5 years for floating (25°C)	
	Eurobat (20°C): 3-5 years, standard commercial.	

Construction

Component	Positive plate	Negative plate	Container	Cover	Separator	Electrolyte	Safety valve	Terminal
Raw material	Lead dioxide	Lead	ABS	ABS	AGM	Sulfuric acid	Rubber	Copper

Constant current discharge characteristics unit: Ampere/Block (at 25°C, 77°F)

F.V/Time	5min	10min	15min	30min	60min	2h	3h	4h	5h	10h	20h
9.60V	11.1	7.02	5.48	3.09	1.90	1.04	0.72	0.59	0.51	0.27	0.15
9.90V	10.7	6.81	5.35	3.03	1.87	1.03	0.71	0.59	0.50	0.27	0.15
10.2V	10.3	6.53	5.15	2.93	1.82	1.02	0.71	0.59	0.50	0.27	0.15
10.5V	9.86	6.25	4.98	2.86	1.79	1.10	0.70	0.58	0.50	0.27	0.15
10.8V	9.31	5.90	4.71	2.76	1.73	0.98	0.68	0.57	0.48	0.27	0.14

Constant power discharge characteristics unit: Watt/Block (at 25°C, 77°F)

F.V/Time	5min	10min	15min	30min	60min	2h	3h	4h	5h	10h	20h
9.60V	124	79.2	62.5	35.4	22.0	12.2	8.54	7.08	6.04	3.30	1.77
9.90V	120	76.8	61.0	34.7	21.7	12.1	8.49	7.04	6.00	3.28	1.76
10.2V	115	73.6	58.7	33.6	21.1	12.0	8.43	6.99	5.96	3.27	1.75
10.5V	110	70.5	56.7	32.8	20.7	11.8	8.37	6.94	5.92	3.25	1.74
10.8V	104	66.5	53.7	31.6	20.1	11.5	8.12	6.73	5.74	3.18	1.71

Note 1: Above characteristics data can be obtained within three charge and discharge cycles.

● Discharge characteristics (25°C)

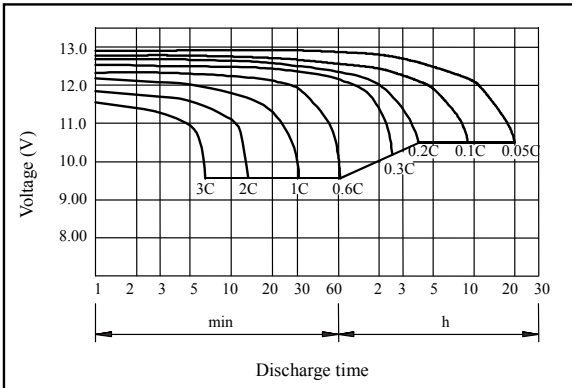

● Charging characteristics (25°C)

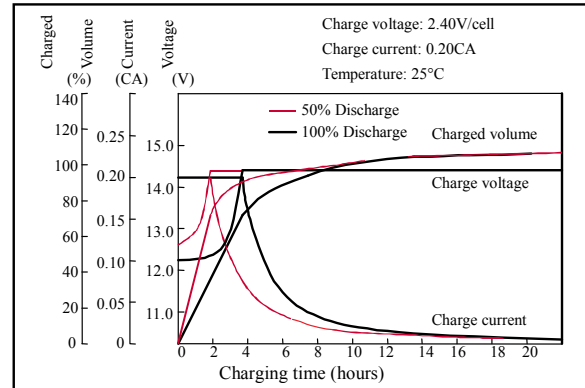

● Temperature effects on capacity

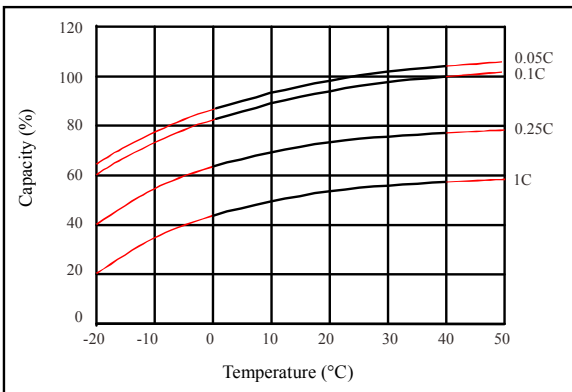

● Self-discharge characteristics

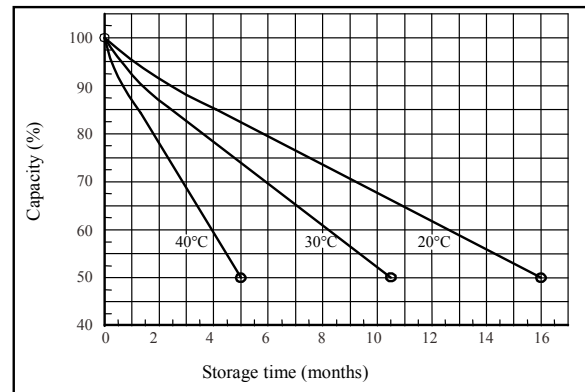

● Floating life on temperature

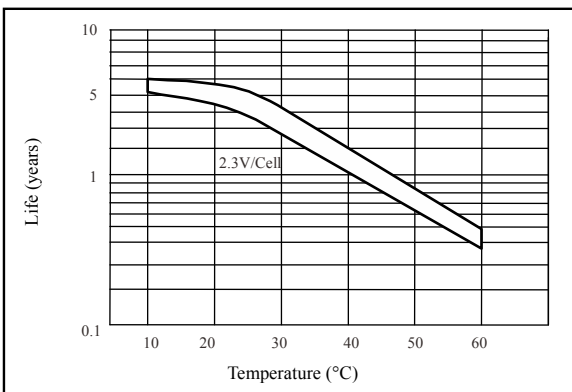

● Cycle life on D.O.D (25°C)

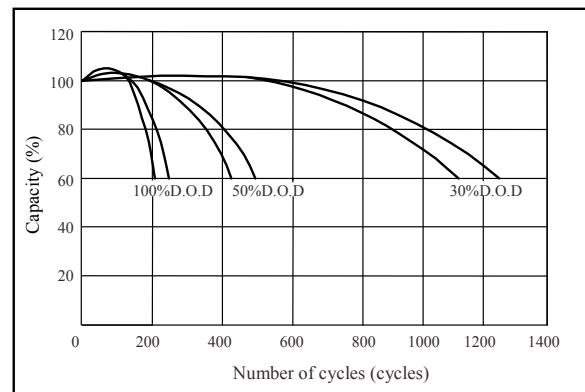

● Relationship for OCV and capacity (25°C)

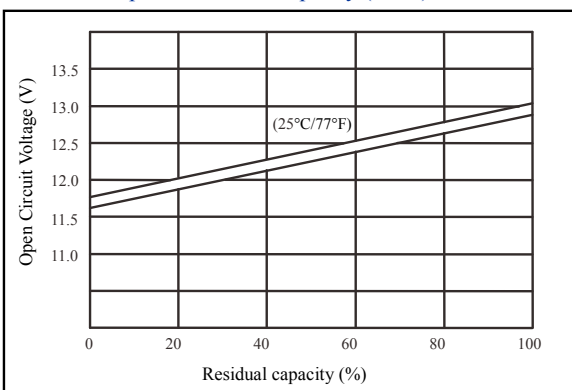

● Relationship for charging voltage and temperature

