

# 42W Constant Current Power Supply

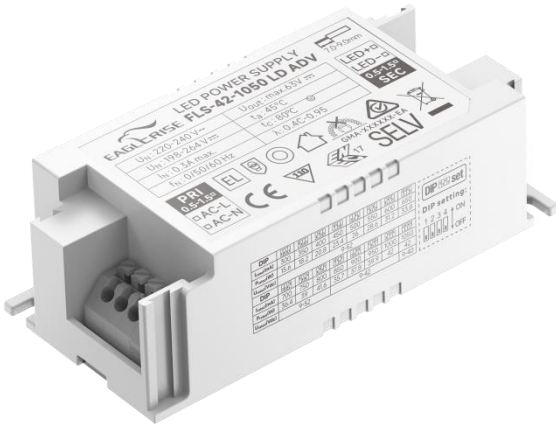

■ Approve



## Features

- Class II, SELV, built-in/independent
- Input Voltage: 220-240VAC
- Protections: SCP/OLP/OVP/OTP
- Power Factor: 0.95
- Efficiency: 88%
- 5 years warranty
- IP20

## Applications

- LED panel, LED down light

## ◆ Description

FLS-42-1050 LD ADV is a 42W constant current LED driver with 300 to 1050mA output current and a forward voltage range from 9 to 52Vdc. The output current is adjustable by DIP Switch. With it's compact dimensions from 97 x 43 x 30 mm it is easy to integrate in LED Panel and down light products. The side covers are available as accessories and allow to use the LED driver independent.

## ◆ Model code

### FLS-42-1050 LD ADV

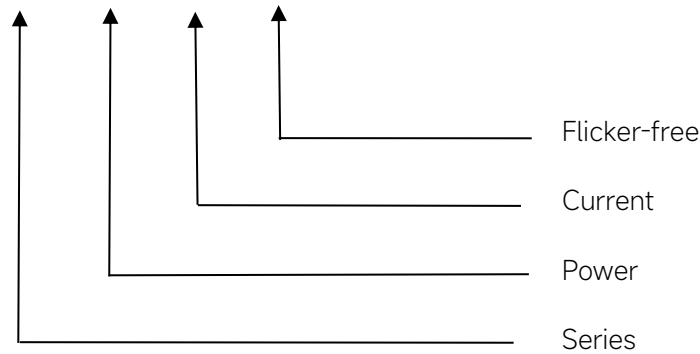

## ◆ Specification

Output	Constant Current (mA)	300mA	.....	800mA	850mA	.....	1000mA	1050mA
	Voltage Range(VDC)	9-52VDC			9-42VDC			9-40VDC
	Unload voltage Max.(VDC)	60VDC						
	Current Accuracy	±5%						
	Output HF current ripple(≥1KHz)	±4%						
	Output LF current ripple(≤120Hz)	±3%						
	SVM	≤0.01						
	Pst	≤0.02						
	Flicker index	0.011						
	Efficiency(Typ.)	88%						
Input	Rated input voltage(VAC)	220-240VAC						
	Range of input voltage(VAC)	198-264VAC						
	Range of input voltage(VDC)	176-264VDC						
	Frequency(Hz)	0/50/60 Hz						
	Displacement factor	≥0.9						
	Power Factor	0.95						
	Input Current max	300mA						
	Start-up time	< 0.5S						
	No Load Power	≤0.5W						
	THD (Typ.)	10%						
	Protection	Over Load Protection	103-150% YES/Auto Resume					
Over Voltage Protection		60VDC YES/Auto Resume						
Short circuit Protection		YES/Auto Resume						
Over Temperature Protection		YES/Auto Resume						
Environment	Operating Temperature	-25°C~+45°C						
	Humidity	20%-90%RH						
	Tc	80°C						
	Storage Temperature	-40°C~+80°C						
	Life time	> 50000h@Tc=80°C						
Surface	Dimension	97X43X30mm (With side caps :131X43X30mm)						
Standards	EN 61347-1,EN 61347-2-13;IEC 61347-1,IEC 61347-2-13;GB 19510.1,GB 19510.14;GB/T 17743,GB 17625.1 AS/NZS 61347.1,AS 61347.2.13;EN 62384;EN IEC 55015,EN IEC 61000-3-2,EN 61000-3-3;EN 61547							
Others	Surge	L-N:1kV, Conforms to class C						
	ErP	EU 2019/2020						
	RoHS	RoHS (2011/65/EU) (EU)2015/863						

Note	<p>1.All parameters NOT specially mentioned are measured at 230VAC input , full load and 25°C of ambient temperature.</p> <p>2.Ripple &amp; Noise are measured at 20MHz of bandwidth by using a 300mm twisted pair-wire terminated with a 0.1uF &amp; 47 uF parallel capacitor.</p> <p>3.Temperature test: tested at high temperature(45°C)/low temperature(-25°C)/normal temperature(25°C)</p> <p>4.Data are typical values obtained from test samples</p>
------	---

## ◆ Parameter

Number	Output				Switch position			
	Current (mA)	Voltage (VDC)	Voltage No load (VDC)	Power (W)	1	2	3	4
1	300mA	9-52VDC	60VDC	15.6	--	--	--	--
2	350mA			18.2	ON	--	--	--
3	400mA			20.8	--	ON	--	--
4	450mA			23.4	ON	ON	--	--
5	500mA			26	--	--	ON	--
6	550mA			28.6	ON	--	ON	--
7	600mA			31.2	--	ON	ON	--
8	650mA			33.8	ON	ON	ON	--
9	700mA			36.4	--	--	--	ON
10	750mA			39	ON	--	--	ON
11	800mA			41.6	--	ON	--	ON
12	850mA			35.7	ON	ON	--	ON
13	900mA	9-42VDC		37.8	--	--	ON	ON
14	950mA			39.9	ON	--	ON	ON
15	1000mA			42	--	ON	ON	ON
*16	1050mA	9-40VDC	42	ON	ON	ON	ON	

## ◆ Circuit Breaker

Ipeak	Twidth	B10	B16	B20	C10	C16	C20
5.88A	47.2µs	22pcs	36pcs	45pcs	22pcs	36pcs	45pcs

◆ **Wiring diagram**

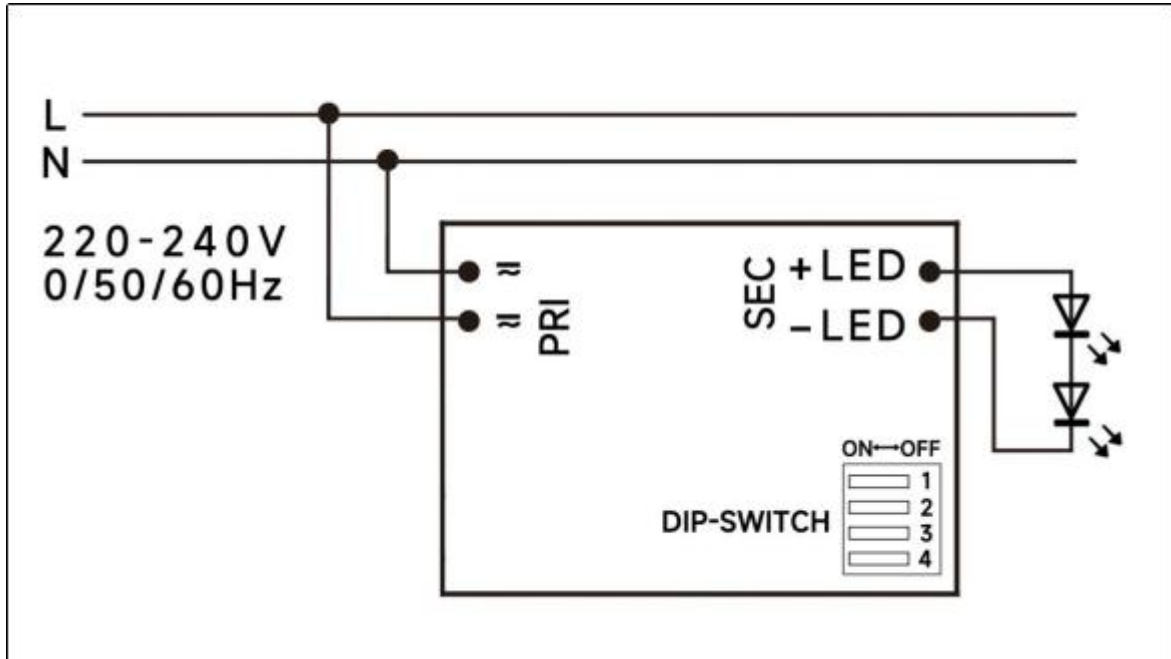

◆ **2D diagram**

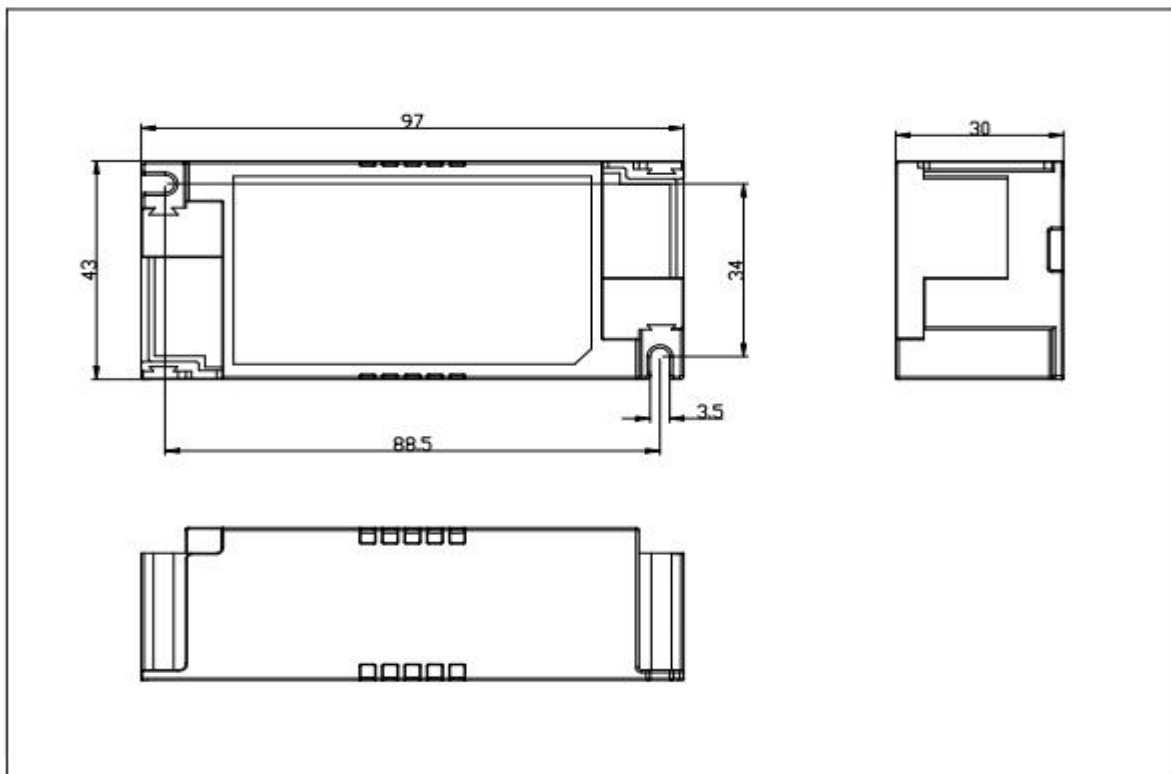

With side caps

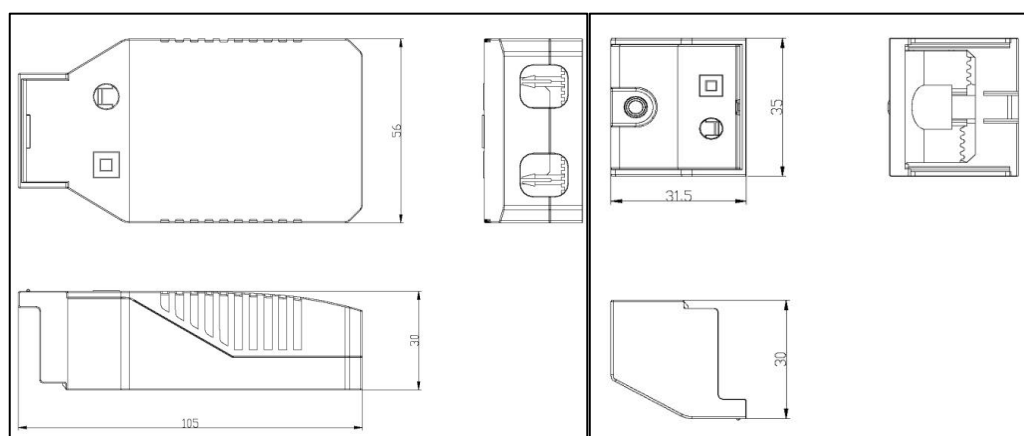
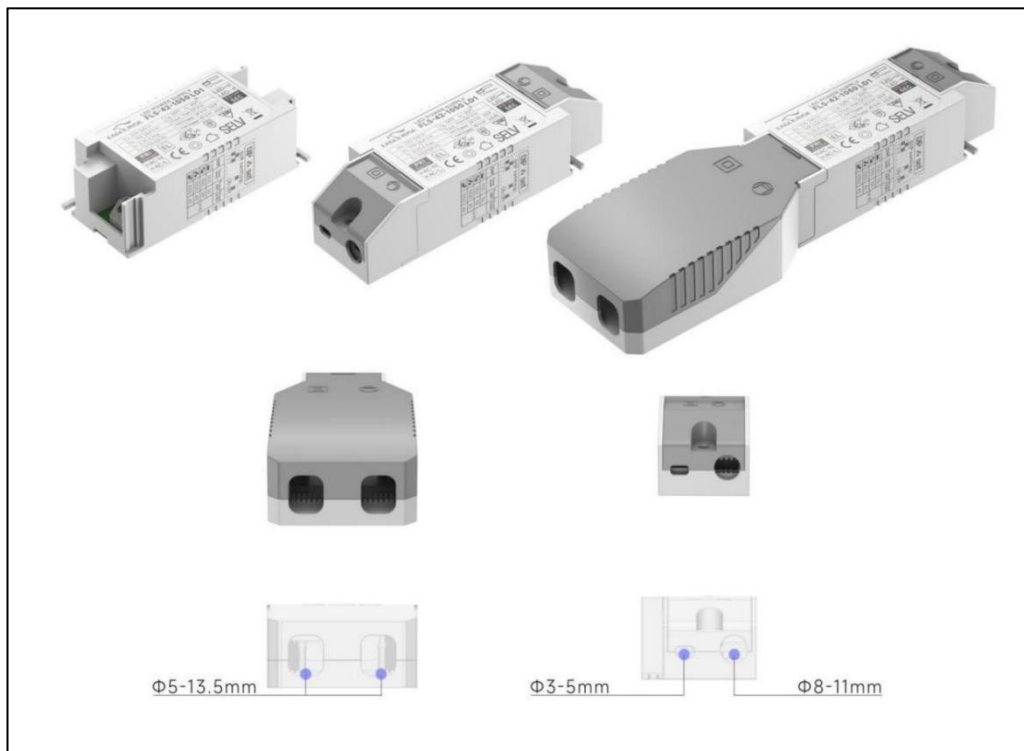

A caps

B caps

## ◆ Wiring & Connections

Specification item		Value (Unit )
Input	Input wire cross-section	0.5...1.5 mm <sup>2</sup> (With A side caps: 0.75...2.5 mm <sup>2</sup> )
	Input wire gauge.	16...20 AWG (With A side caps: 14...20 AWG )
	Input wire strip length	7...9mm
Output	Output wire cross-section	0.5...1.5 mm <sup>2</sup>
	Output wire gauge.	16...20 AWG
	Output wire strip length	7...9mm

Common ways of wire clamping:

1. Tighten the screws to secure the side cover or clips, to clamp the cables
2. Through the main shell and side cover side teeth to clamp the cables

◆ **Curve for FLS-42-1050 LD ADV, I<sub>o</sub>=1050mA**

Lifetime vs. Temperature Curve

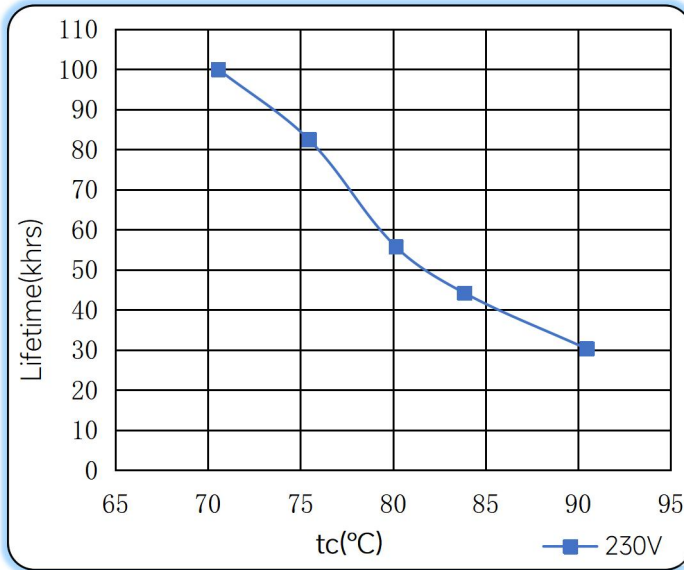

Efficiency vs. Load

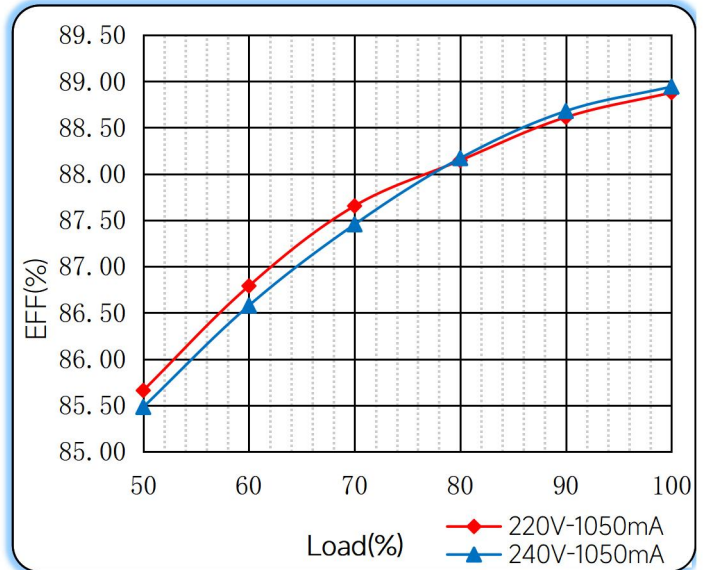

Power Factor Characteristics

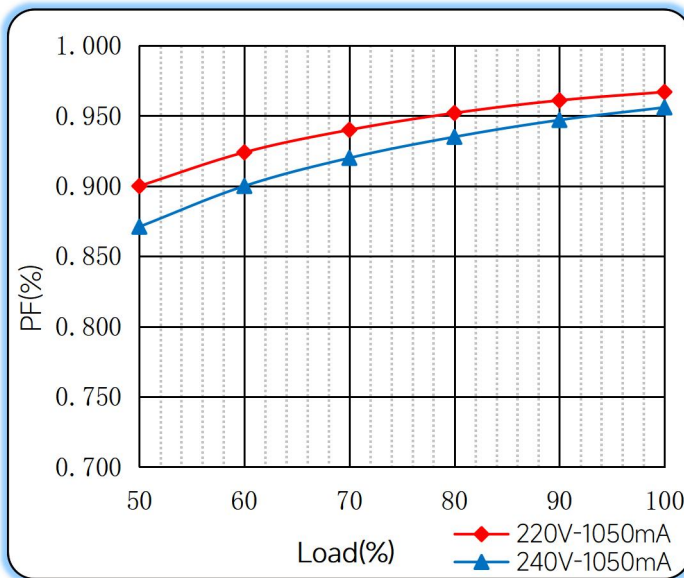

THD vs. Load

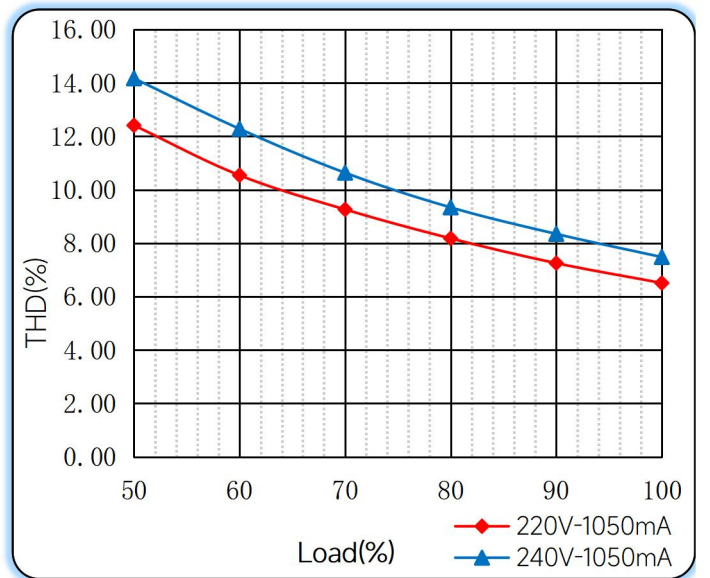

### ◆ Operating window

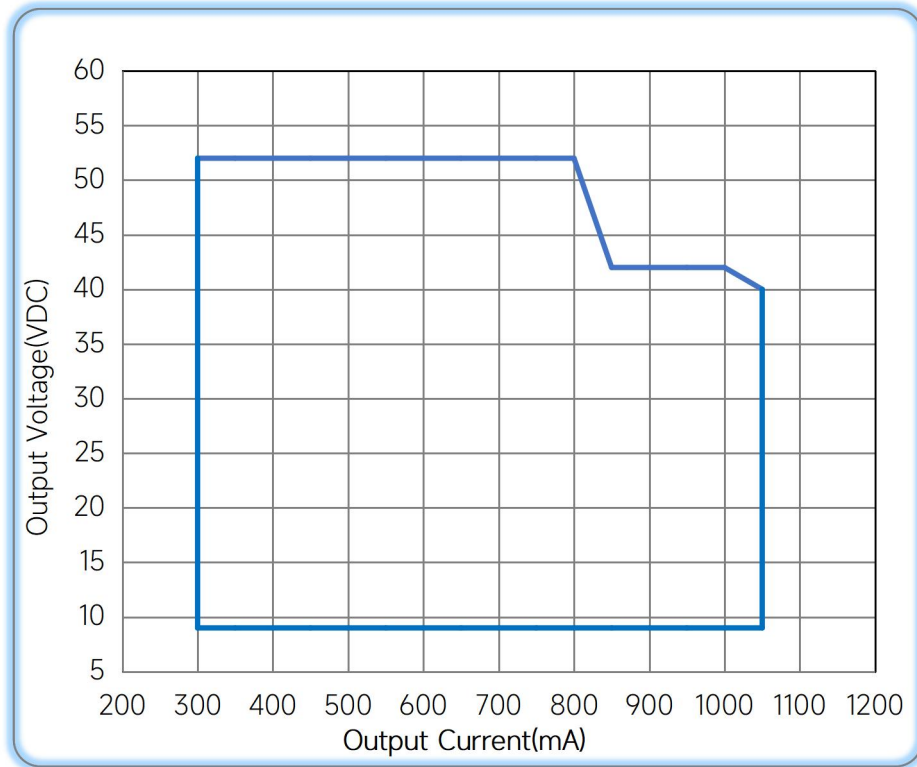

— Operating window 100%

### ◆ Revision Updates

ITEM	BEFORE	AFTER	VERSION	DATE
Initial			A	2022/10/13
Specification		Updated	B	2023/01/30

Tel: +86-0757-86256822, +86-0757-86256831

E-mail: sales@eaglerise.com

Website : <https://lighting.eaglerise.com>



EAGLERISE



Manual