

NPD12-20Ah (12V20Ah)

Valve Regulated Lead Acid Battery



Specifications

Nominal voltage	12V (6 cells per unit)	
Rated capacity (20HR)	20Ah/10.5V	
Dimensions	Length	181±2mm (7.13inch)
	Width	77±1mm (3.03inch)
	Height	167±2mm (6.57inch)
	Total height	167±2mm (6.57inch)
Approx. weight	5.80kg (12.78lbs)±4%	

Outer dimensions (mm)

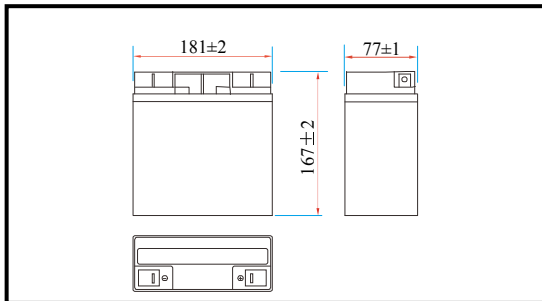

Terminal type (mm)

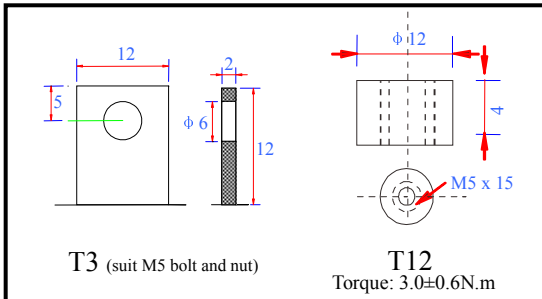

Characteristics

Capacity (25°C)	20HR (10.5V)	20Ah
	10HR (10.5V)	19Ah
	1HR (9.60V)	12Ah
Terminal type		T3/T12
Internal resistance (Fully charged, 25°C)		Approx. 12mΩ
Capacity affected by temperature (10HR)	40°C	102%
	25°C	100%
	0°C	85%
	-15°C	65%
Self-discharge (25°C)	3 months	Remaining capacity: 91%
	6 months	Remaining capacity: 82%
	12 months	Remaining capacity: 65%
Nominal operating temperature		25°C±3°C (77°F±5°F)
Operating temperature range	Discharge	-15°C~50°C (5°F~122°F)
	Charge	-10°C~50°C (14°F~122°F)
	Storage	-20°C~50°C (-4°F~122°F)
Float charging voltage (25°C)		13.60 to 13.80V Temperature compensation: -18mV/°C/Block
Cyclic charging voltage (25°C)		14.50 to 15.00V Temperature compensation: -30mV/°C/Block
Maximum charging current		6A
Maximum discharge current		300A (5 sec.)
Design life	8 years for floating (25°C)	
	Eurobat (20°C): 6-9 years, general purpose	

Construction

Component	Positive plate	Negative plate	Container	Cover	Separator	Electrolyte	Safety valve	Terminal
Raw material	Lead dioxide	Lead	ABS	ABS	AGM	Sulfuric acid	Rubber	Copper

Constant current discharge characteristics unit: Ampere/Block (at 25°C, 77°F)

F.V/Time	5min	10min	15min	30min	60min	2h	3h	4h	5h	10h	20h
9.60V	78.3	49.6	38.7	21.8	13.4	7.35	5.08	4.2	3.58	1.94	1.04
9.90V	76.0	48.1	37.8	21.4	13.2	7.30	5.05	4.18	3.55	1.93	1.04
10.2V	72.8	46.1	36.4	20.7	12.9	7.24	5.02	4.15	3.53	1.92	1.03
10.5V	69.7	44.2	35.2	20.2	12.6	7.13	4.98	4.12	3.51	1.91	1.03
10.8V	65.8	41.7	33.3	19.5	12.2	6.95	4.83	4.00	3.40	1.87	1.00

Constant power discharge characteristics unit: Watt/Block (at 25°C, 77°F)

F.V/Time	5min	10min	15min	30min	60min	2h	3h	4h	5h	10h	20h
9.60V	874	560	442	250	155	85.9	60.4	50.1	42.7	23.3	12.5
9.90V	848	543	431	245	153	85.4	60.0	49.8	42.4	23.2	12.4
10.2V	813	520	415	238	149	84.7	59.6	49.4	42.1	23.1	12.4
10.5V	778	498	401	232	146	83.4	59.2	49.1	41.9	23.0	12.3
10.8V	734	470	380	223	142	81.3	57.4	47.6	40.6	22.5	12.1

Note 1: Above characteristics data can be obtained within three charge and discharge cycles.

● Discharge characteristics (25°C)

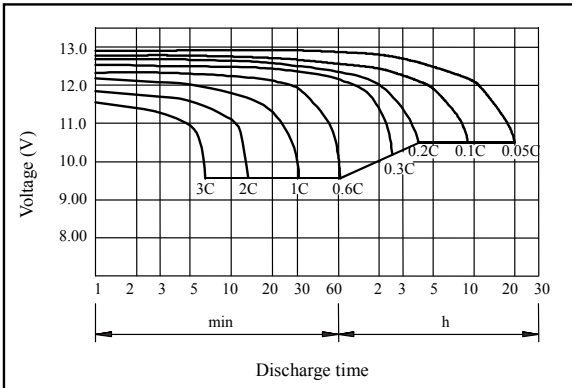

● Charging characteristics (25°C)

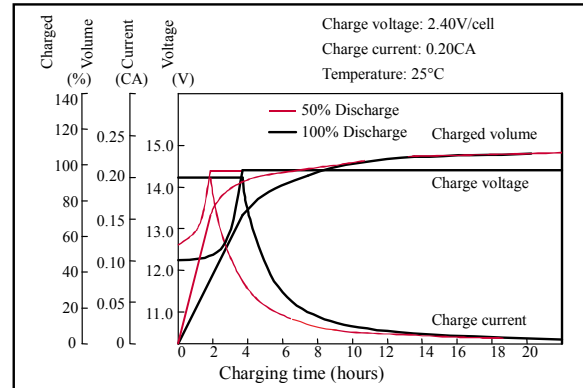

● Temperature effects on capacity

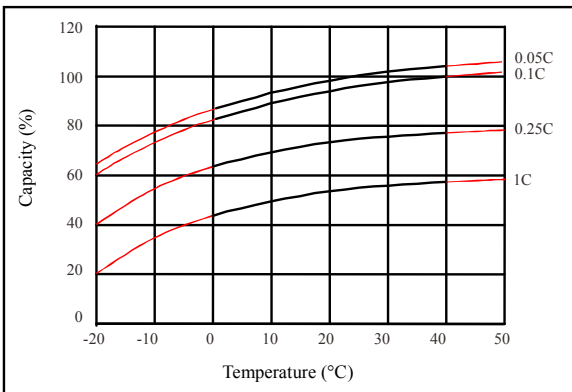

● Self-discharge characteristics

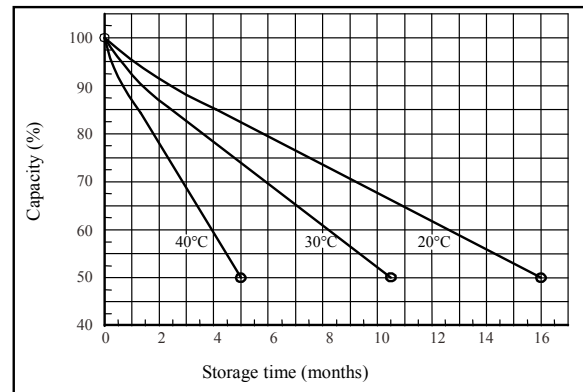

● Floating life on temperature

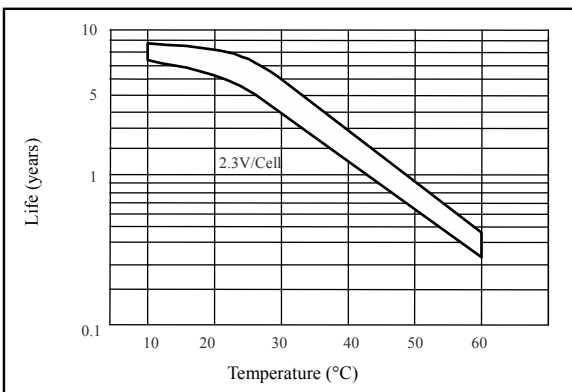

● Cycle life on D.O.D (25°C)

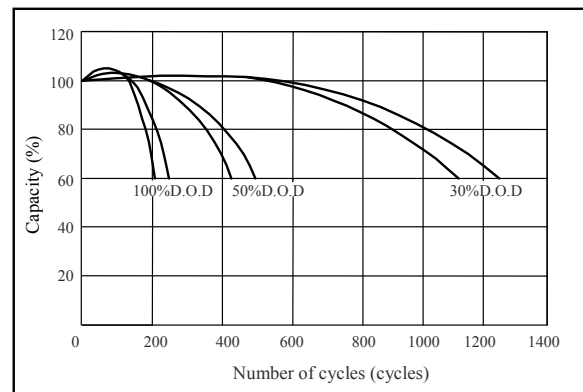

● Relationship for OCV and capacity (25°C)

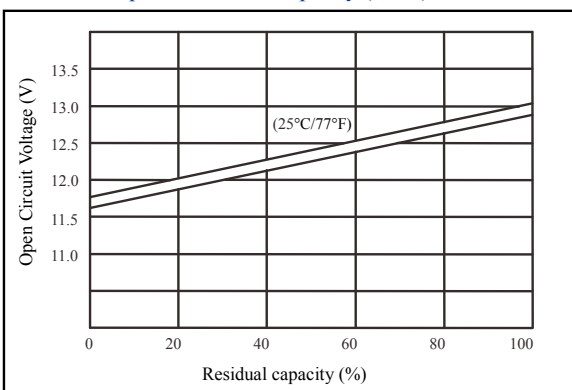

● Relationship for charging voltage and temperature

